



## Web-Server

## OZW672... V4.0

For LPB/BSB plants

**Web server OZW672... allows for remote plant control and monitoring via the web and Smartphone-App. Web server is available in three versions: To connect 1 LPB/BSB unit or 4 or 16 LPB units for the Sigmagyr / Albatros and Albatros2 ranges.**

- Operate via web browser with PC/laptop and Smartphone.
- Operate via Smartphone app (iPhone and Android).
- Plant visualization in the web browser based on customized plant web pages. Operation via ACS790 PC tool.
- Connection types: USB and Ethernet.
- 2 digital inputs for fault messages.
- Display fault messages in the web browser.
- Send fault messages to a maximum of 4 e-mail recipients.
- Periodically send system reports to e-mail recipients.
- Function "Energy indicator" to monitor data points for energy-related limit values, or "Green limits".
- Web services for external applications via Web API (Web Application Programming Interface).
- Encrypted with https and TLS for emails.
- Full ACS790 functionality.

## Use

### Buildings

- Apartments in single and multi-family homes.
- Office and administrative buildings, residential housing.
- Schools, gymnasiums, leisure facilities, hotels.
- Municipal buildings, commercial and smaller industrial buildings.

### Owners/operators

- End customers, HVAC and electrical installers, heating manufacturers.
- Real estate agencies, real estate management companies, service organizations.
- Building maintenance companies, facility management.

## Functions

### Commissioning

Commissioning is carried out via PC/Laptop and Web browser or ACS.

### Web operation

- Remotely operate and monitor plants and devices on a LPB/BSB network using a web browser on PC/laptop and Smartphone.
- Simultaneous support of multiple users.
- User accounts for web operation (user groups, operating language).
- Set up customized plant web page features.

### Web user interface

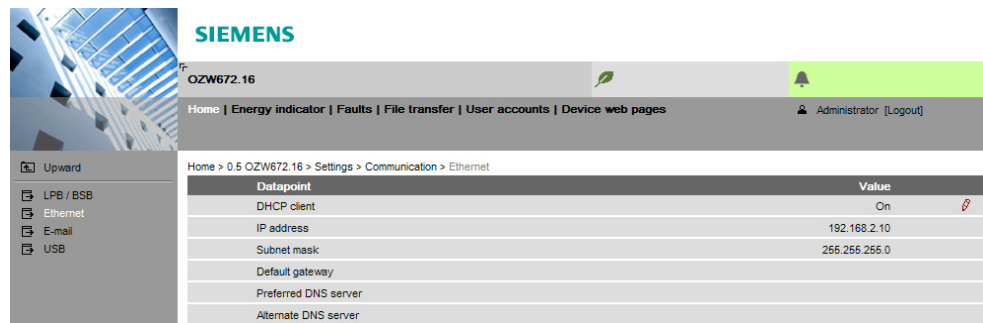

### Primary navigation

Primary navigation offers the following functions:

<b>Home</b>	Menu-based plant and device operation.
<b>Energy indicator</b>	Display and operate "Energy indicator" data points.
<b>Faults</b>	Display system faults.
<b>File transfer</b>	Download consumption data and event history, upload documents, logos and system definitions.
<b>User accounts</b>	User administration.
<b>Device web pages</b>	Create device list and operating pages.

### Secondary navigation

The secondary navigation (menu tree) allows users to select devices and operating pages.

### Display

The display range displays content corresponding to the selected primary and secondary navigation.

### Plant state

The display indicates no fault or the most serious plant fault depending on plant state.

## Faults

Fault sources	The web server recognizes failures and fault signals from LPB/BSB devices contained in the device list. Faults from digital inputs and own faults are detected also.
Fault indication	The LED  signals a fault on the web server. The LED is lit for as long as the fault is present.
Fault status message	Fault status messages can be sent as an e-mail to as many as 4 e-mail recipients and/or via a service provider to SMS recipients. You can set the fault priority for each email recipient (urgent/all). Each receiver has a "Time switch with calendar" to program three sending times per day and holidays/special days.

## System report

System messages	The web server generates system reports and periodically sends the system state to e-mail recipients. Messages are sent as per the set time (hh:mm), the message cycle interval (1...255 days), and priority (urgent/non-urgent).
Connection test	Press the  button on the web server to send a system report to all defined email recipients regardless of fault priority.

## History

The last 500 fault events, fault messages and system reports are entered in the web server's circular message buffer. The events or history data can be read via web browser.

## Time of day

The web server has a system clock with adjustable daylight saving/standard time changeover. Clock time mode can be configured autonomous, or as either master or slave.

## Software updates

We differentiate between the following:

- System definition updates to integrate device descriptions of new devices in the web server.
- Firmware updates to update the web server to the latest firmware version. Firmware updates may also contain new device descriptions (system definitions).

A system definition update requires one simple action via the web browser. No operator actions on the web server are required to update the firmware. Procedures are communicated when a firmware update is issued.

## ACS790

Full ACS790 functionality is available together with the web server:

- Popcard and plant diagrams.
- Parameterization and commissioning protocol.
- Trend.
- Device search.

## Visualize plants

Web server OZW672... allows for visualizing technical equipment in buildings via plant web pages. For example, a plant web page can be set up visualizing a plant with data points (max. 100 data points per plant web page) on a floor plan.

In the event of a fault, users can quickly access the impacted locations.

For writable parameters, users can click to open a dialog box and change the parameter (as e.g. the "Room temp reduced setpoint" displayed below).

## Full screen

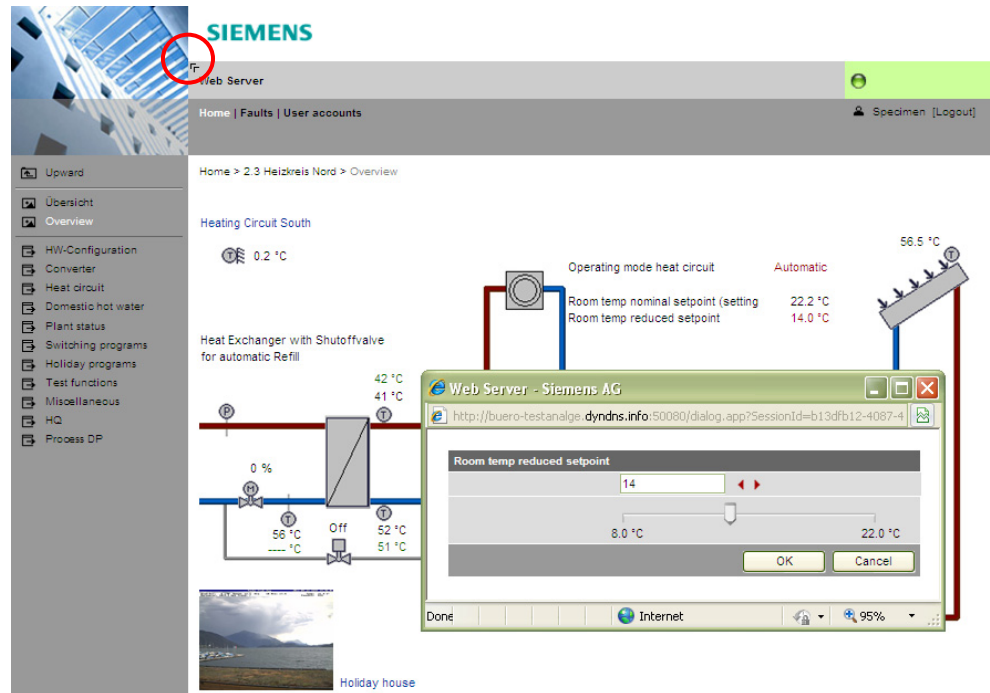

## Partial screen

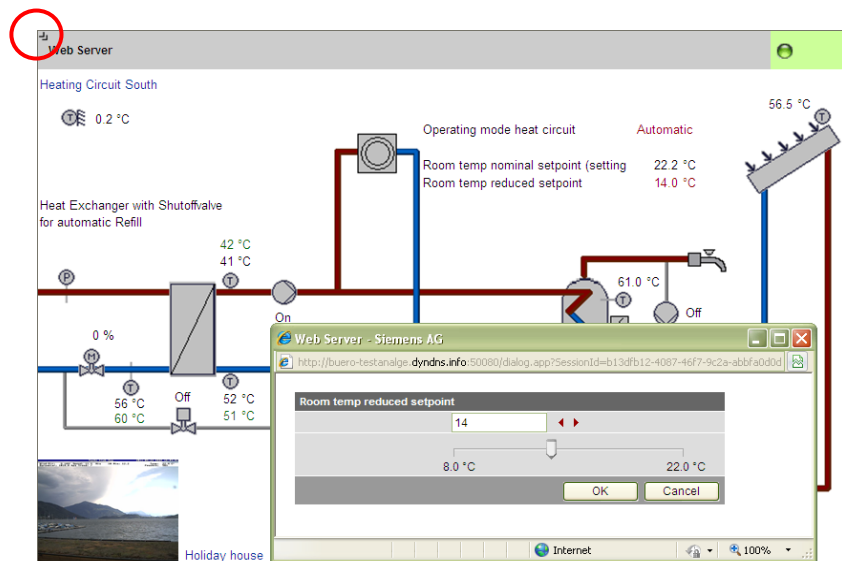

## Import plant diagrams

For standard LPB/BSB controller applications, web-capable plant diagrams can be exported from ACS790 and imported in the web server.

## Create own plant web pages

You can freely design plant web pages. As a hybrid form, you can also modify and extend downloaded plant diagrams.

## Web page elements

Users can also embed additional data in a plant diagram such as links to plant, function and maintenance descriptions or data sheets. Moreover, users can integrate external links allowing, for example, to directly browse multiple plants. Users can embed current webcam images in a plant diagram.

**Function**  
**"Energy indicator"**

Function "Energy indicator" is available on the OZW672... web server from V4.0.

The web server uses the "Energy indicator" function to read selected data point values from the LPB and BSB bus devices and to compare the values to energy-related limit values, or so-called "Green limits".

The data points are also monitored for adherence to the "Green limits". As a result, the "Energy indicator" is displayed in the form of a tree leaf.

Note

The "Green limits" are used only together with the "Energy indicator" function. They do **not** represent process or safety limit values which trigger e.g. fault messages or turn off the plant in the event of limit violations.

**Tree leaf as**  
**"Energy indicator"**

Green leaf 

"Green leaf" → Green tree leaf, leaf pointing up.

- The "Green leaf" symbol indicates that a data point value has not exceeded its "Green limit", i.e. the value is within a "green" range in terms of energy consumption.

Orange leaf 

"Orange leaf" → Orange tree leaf, leaf pointing down.

- The "Orange leaf" symbol indicates that a data point value has exceeded its "Green limit", i.e. the value is outside a "green" range in terms of energy consumption.

Standard EN 15232



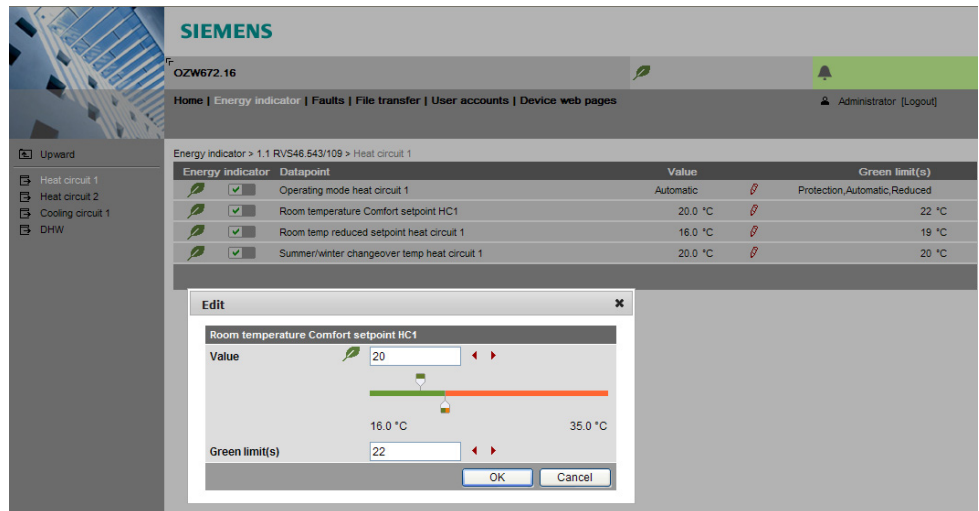

The "Energy indicator" function is based on standard EN 15232 "Energy efficiency in buildings".

**Example: Web page**  
**"Energy indicator"**

Web page with "Energy indicator" function; example with data points from "Heat circuit 1" and open dialog box to set data point value "Room temperature Comfort setpoint HC 1" and its "Green limit".



The screenshot shows the Siemens OZW672.16 web interface. The main content area displays a table of energy indicators for Heat circuit 1. An 'Edit' dialog box is open, allowing the user to adjust the 'Room temperature Comfort setpoint HC1' value and its 'Green limit(s)'. The dialog box includes a value input field set to 20, a green bar representing the range from 16.0 °C to 35.0 °C, and a green limit input field set to 22. The background table shows the following data:

Energy indicator	Datapoint	Value	Green limit(s)
	<input checked="" type="checkbox"/> Operating mode heat circuit 1	Automatic	Protection,Automatic,Reduced
	<input checked="" type="checkbox"/> Room temperature Comfort setpoint HC1	20.0 °C	22 °C
	<input checked="" type="checkbox"/> Room temp reduced setpoint heat circuit 1	16.0 °C	19 °C
	<input checked="" type="checkbox"/> Summer/winter changeover temp heat circuit 1	20.0 °C	20 °C

## Web services

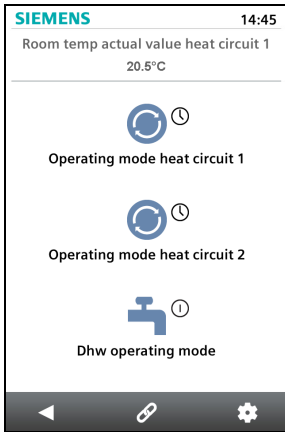

The "Web Application Programming Interface" (Web API) is an interface to make web services on a web server accessible to clients.

All Web API functions are called up via "http" or encrypted "https". Each session begins with authentication on the web server.

If the "HomeControl App" is installed on a smartphone, the web services can access the data points of the devices on the LPB network via the Web API (communication connection for smartphone see page 7).

## Type summary

Name		Product number
Web server	for 1 LPB/BSB device	OZW672.01
Web server	for 4 LPB devices	OZW672.04
Web server	for 16 LPB devices	OZW672.16

## Ordering and delivery

When ordering, please specify the name and **product number**.

Example: Web server **OZW672.16**

The web server is delivered in a cardboard box.

The following is included in the package:

- Installation instructions G5711xx (multilingual).
- Power cable, power supply AC 230 V.
- Ethernet cable.
- USB cable.
- 2 cable ties.

### Note

The commissioning instructions C5712 (de / en) are available on the web server at <http://<IP-Adresse>/doc/>

## Equipment combinations

### LPB/BSB devices

The following devices from the Sigmagyr/Albatros product range can be connected to each OZW672... web server via LPB/BSB.

- Heating controllers RVL4..., RVP3..
- District heating controller RVD2..
- Universal controller RVP5..
- Heating controllers RVA..., RVS..., RVC..
- Boiler management units LMU..., LMS..

### Note

Download a detailed list of compatibility of LPB/BSB devices from [www.siemens.com/sigmagyr](http://www.siemens.com/sigmagyr) (right-click Tools > Downloads for HVAC controllers).

## Product documentation

	Document type	Document no.
Web server OZW672...	Data sheet (this document)	<b>N5712</b>
	Installation instructions (package insert)	<b>G5711</b>
	Commissioning instructions	<b>C5712</b>
	CE declaration of conformity	<b>T5711</b>
	Environmental product declaration	<b>E5711</b>
ACS790 software	Data sheet	<b>N5649</b>
Service tool OCI700.1	Data sheet	<b>N5655</b>

## Technical design

Web browser	Devices	Demand
	PC/Laptop (1024 x 786)	Internet Explorer V7.0 or higher. Firefox V3.0 or higher.
	iPhone	Safari (specific to end device)

**Concurrent operation** Concurrent operation is unlimited. The maximum data throughput is shared between the users. Operation slows down as the number of users increases accordingly.

**Operation, monitoring, alarming** Communication connections for local commissioning (USB) and remote operation, remote monitoring and alarming via Ethernet.

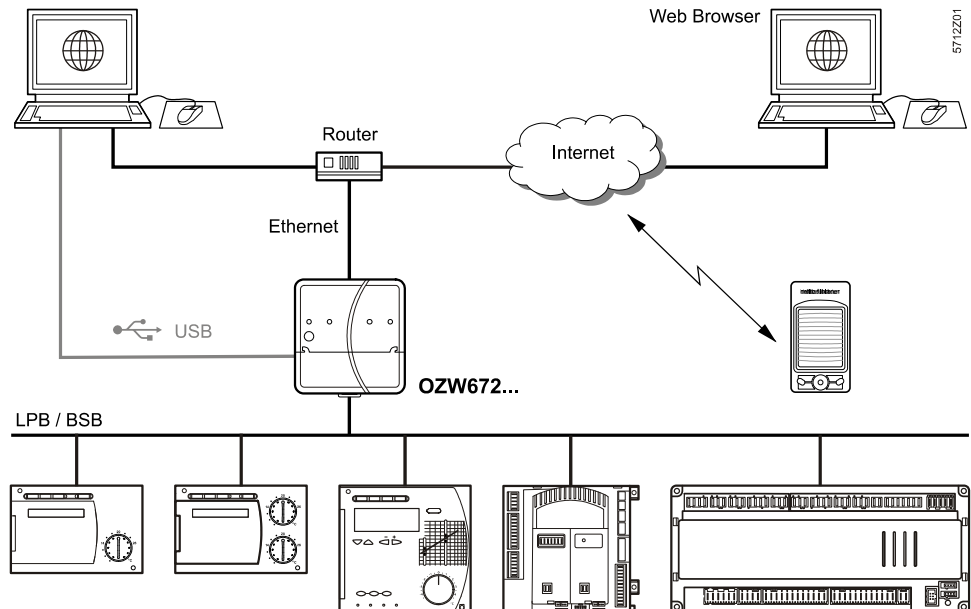

## Interfaces

**USB** The USB interface directly connects the PC/laptop on site. The required USB cable type A – type Mini-B is delivered with the device.

**Ethernet** The router/network is connected to the Ethernet RJ45 plug. The Ethernet interface features Auto-MDI(X) for crossed and non-crossed Ethernet cables. An Ethernet category 5 cable is supplied.

LPB/BSB The LPB/BSB bus is connected to terminals DB/CL+ and MB/CL- designated "A ". For information on the LPB/BSB bus, see Local Process Bus System Engineering, basic documentation P2370.

Digital inputs The digital inputs D1, D2 help connect potential-free status contacts. They work as fault inputs.

### Protocols

Web operation Use HTTP (Port 80) via TCP / IP for web operation. In addition, https encryption via port 443 is supported. The required certificate is not accredited. The self-signed certificate from Siemens is valid for 20 years and is installed on the web server. The certificate can be installed on the web browser as needed.

A RNDIS driver on the PC/laptop is required for USB communication. The RNDIS driver is automatically installed on PC/laptops connected to the Internet (provided the network administrator enables "online update"). The RNDIS driver is also saved to the web server under <http://<IP address>/drivers/>

Send email Fault messages and "Energy indicator" report are sent in an email via SMTP. The email is encrypted using TLS if supported by the mail server.

DHCP client The web server can take over its network configuration as a client of a DHCP server.

## Mechanical design

### Design

The web server consists of the housing lower section with printed circuit boards and interfaces as well as connection terminals. The upper housing section contains the printed circuit boards. The upper housing section contains the LED displays and one operating button. The connection terminals and additional display and operating elements are located under the removable cover for the upper housing section. All display and operating elements are labeled.

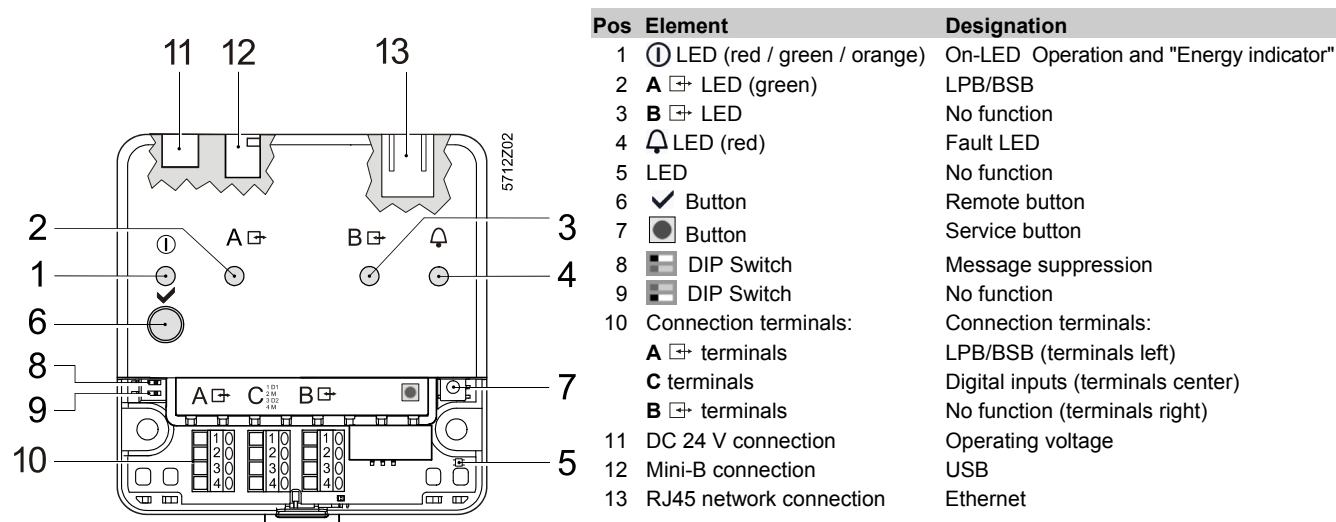



## Notes

---

### Mounting

You can mount the web server in a panel, distribution box, or on a wall. Include space for wiring when planning. Make sure service can easily access the unit and the unit is ventilated properly.

- Standard mounting                      On standard rail TH 35-7.5.
- Wall mounting.                            Attached with 2 screws.
- Mounting position                        Horizontal or vertical.
- Mounting and dimensions                See "Dimensions".

### Install

#### Important notes

Observe the following when installing:

- Run fuses, switches and wiring as per local regulations for electrical installations.
- We do not recommend plant monitoring via USB interface in environments with strong electromagnetic interference (e.g. in industrial environments with electrical welding equipment).
- See "Technical data" for electromagnetic compatibility.

#### Operating voltage

The supplied AC 230 V power supply provides the DC 24 V operating voltage for the web server.

#### Wiring

The operating voltage, USB and Ethernet plugs are located on the upper part of the housing.

The terminals on the device for the LPB/BSB bus are located under the removable cover.

#### Connection terminals

The connection terminals are designed for wire diameters of min. 0.5 mm or cross-sections of 0.25...1.5 mm<sup>2</sup> or stranded wire cross-sections of 0.25...1.0 mm<sup>2</sup>.

### Commissioning

#### Connections

The web server is commissioned locally via USB with a PC/laptop. A web browser must be installed on the PC/laptop. As an alternative, the web server can be commissioned using ACS790. The supplied USB cable type A – Type Mini-B connects the web server to the PC/laptop.

Additional information is available in the installation instructions G5711 inserted in the package or the commissioning instructions C5712, available at:

<http://<IP address>/doc/>

#### Router



You need a suitable router for remote operation via Internet. The router must support NAT/PAT as well as DynDNS for dynamic IP addressing.

#### IP address

- The IP address via USB is set: **192.168.250.1**.
- Default setting for the IP address via Ethernet: **192.168.2.10**.
- The network administrator must provide an IP address for the web server before you can connect the web server via Ethernet to a managed network.

<b>User groups</b>	User accounts are created and assigned to specific user groups for customized user operation.
End-user	<ul style="list-style-type: none"> <li>• Access to end-user data and fault overview.</li> <li>• Operate and monitor via menu tree and plant diagrams.</li> <li>• Administer own user accounts.</li> </ul>
Technical service	<p>Same as end user. In addition:</p> <ul style="list-style-type: none"> <li>• Access service data.</li> <li>• Download consumption data and message history.</li> <li>• Upload customized logos and documents.</li> <li>• System definitions update.</li> <li>• Update device web pages.</li> </ul>
Administrator	<p>Same as service. In addition:</p> <ul style="list-style-type: none"> <li>• Edit device list.</li> <li>• Create device web pages.</li> <li>• Create, copy, change, and delete plant diagrams.</li> <li>• Select "Energy indicator" data points and change the default values of the data points and/or "Green limits" as needed.</li> <li>• Administer all user accounts.</li> </ul>
<b>Maintenance</b>	<p>The OZW672... web server is maintenance free (no battery changes, no fuses). Clean the housing only with a dry towel.</p>
<b>Repair</b>	<p>The OZW672... web server cannot be repaired on site. If faulty, return to the Repair Center at the relevant Regional Company.</p>
<b>Disposal</b>	<div style="display: flex; align-items: center;">  <div> <p><i>Dispose of the device as electronic waste in compliance with European directive 2002/96/EEC (WEEE) and not as municipal waste. The corresponding national, legal regulations must be observed and the device must be disposable via the appropriate channels. Observe all local and applicable laws.</i></p> </div> </div>

## Technical data

<b>Power cable for web server OZW672...</b>	Operating voltage	AC 230 V ± 15 %
	Rated voltage "Euro plug"	AC 230 V EN 50075 and VDE 0620-1
	Frequency	50/60 Hz
	Power consumption (including web server OZW672...)	3 VA typical
	Protection class	II.
	Output voltage	SELV 24 VDC
	Supply line fusing	Max. 16 A
	Cable length (distance from AC 230 V plug to web server)	Max. 1.6 m
<b>Web server OZW672...</b>	Operating voltage	SELV 24 VDC ± 5 %, 625 mA max.
	Power consumption	2 W typical
<b>Functional data</b>	Clock reserve	Min. 72 hours
	Device list	
	OZW672.01 OZW672.04 OZW672.16	1 LPB/BSB device Max. 4 LPB devices Max. 16 LPB devices
<b>LPB/BSB bus</b>	Interface type 2-wire bus Bus load	2-wire connection DB/CL+, MB/CL- (non-exchangeable) E 5
	Permissible line length and cable types	See: Local Process Bus, System engineering, Basic documentation P2370
	Connection, screw terminals for Solid/stranded wire (twisted or with ferrule) 1 solid wire per terminal 1 stranded wire per terminal	Min. dia. 0.5 mm 0.25...1.5 mm <sup>2</sup> 0.25...1.0 mm <sup>2</sup>
<b>USB</b>	Interface type Device class Baud rate	USB V2.0 RNDIS Max. 12 Mbps (full speed)
	Connecting cable Cable length Cable type for connection to PC/laptop Cable type for connection to OZW672...	Max. 3 m USB type A USB type Mini-B
<b>Ethernet</b>	Interface type Bit rate Protocol Identification	100BaseTX, IEEE 802.3 compatible Max. 100 Mbps TCP/IP Auto MDI-X
	Connection, plug Cable type Cable length	RJ45 plug (screened) Standard Cat-5, UTP or STP Max. 100 m
<b>Standards</b>	Product safety Information technology equipment - Safety	EN 60950-1
	Electromagnetic compatibility Immunity (Industrial sector) Emissions (domestic, business, commercial and light industrial environments)	EN 61000-6-2 EN 61000-6-3
	 Conformity EMC guidelines Low voltage directive Ecodesign directive	2004/108/EC 2006/95/EC 2005/32/EC
	 Conformity Australian EMC Framework Radio Interference Emission Standard	AS/NZS 61000-6-3
	Environmental compatibility The product environmental declaration CE1E5701en contains data on environmentally compatible product design and assessments (RoHS compliance, materials composition, packaging, environmental benefit, disposal)	ISO 14001 (environment) ISO 9001 (quality) SN 36350 (environmentally compatible products) 2002/95/EC (RoHS)

<b>Degree of protection</b>	Protective category	IP30 to EN 60529
	Protection class	III as per EN 60950-1
<b>Ambient conditions</b>	Operation	IEC 60721-3-3
	Climatic conditions	Class 3K5
	Temperature (housing and electronics)	0...50 °C
	Humidity	5...95 % r. h. (non-condensing)
	Mechanical conditions	Class 3M2
	Transport	IEC 60721-3-2
	Climatic conditions	Class 2K3
	Temperature	-25...+70 °C
	Humidity	<95 % r. h.
	Mechanical conditions	Class 2M2
<b>Materials and colors</b>	Upper housing section	PC + ASA, RAL 7035 (light-gray)
	Lower housing section	PC + ASA, RAL 5014 (dove blue)
<b>Dimensions</b>	Length x width x height (max. dimensions)	87.5 mm x 90.0 mm x 39.2 mm
<b>Weight</b>	Web server OZW672...	0.136 kg
	Web server with packaging, installation instructions, power unit, USB and Ethernet cable, cable ties.	0.589 kg
	Packaging	Cardboard box
<b>Terms, abbreviations</b>	Auto Medium Dependent Interface - Crossed	Auto-MDI(X)
	Boiler System Bus	BSB
	Dynamic Domain Name System	DynDNS
	Dynamic Host Configuration Protocol	DHCP
	HVAC Integrated Tool von Siemens	HIT
	Hyper Text Transfer Protocol	HTTP
	Hyper Text Transfer Protocol Secure	HTTPS
	Internet Protocol	IP
	Local Process Bus	LPB
	Network Address Translation	NAT
	Port and Address Translation	PAT
	Remote Network Driver Interface Specification	RNDIS
	Shielded Twisted Pair	STP
	Simple Mail Transfer Protocol	SMTP
	Transport Layer Security	TLS
	Transmission Control Protocol	TCP
	Universal Serial Bus	USB
	Unshielded Twisted Pair	UTP
	Web Application Programming Interface	Web API

## Connection diagrams

### Connection diagram

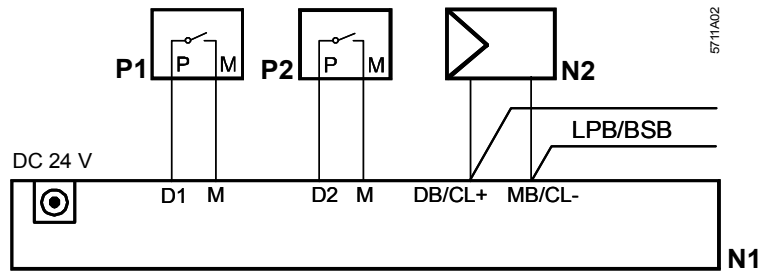

- N1 Web server  
 N2 LPB/BSB device  
 P1, P2 Devices with potential-free contact output for fault indication

### Connection terminals

LPB/BSB bus  
 Digital inputs

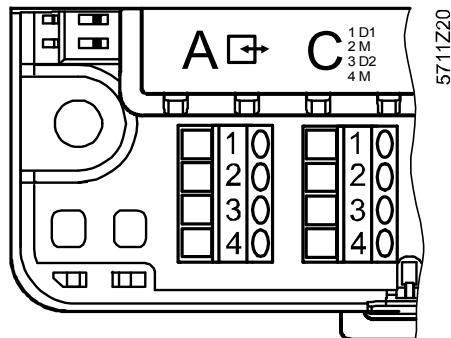

LPB/BSB	Digital
A	C
1 DB/CL+	1 D1
2 DB/CL+	2 M
3 MB/CL-	3 D2
4 MB/CL-	4 M

Operating voltage  
 DC 24 V

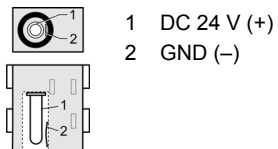

## Dimensions

---

